



Euro6IX



The Pan-European IPv6 IX Backbone



Jordi Palet (jordi.palet@consulintel.es)

Project Coordinator



Euro6IX: The Concept

- How to pronounce it: forget IX and read 6 (“SIX”)
- Build a large, scalable and native IPv6 Backbone of Traffic Exchanges, with connectivity across Europe and other IPv4/v6 Exchangers
- In order to promote and allow other players to trial v6 and port/develop key applications and services
- In order to break the chicken and egg issue !
- Gain REAL IPv6 experience, in a real world with not just research users, involving Telcos/ISPs/ASPs, among others: Allow new players into our trials
- Bring IPv6 into a production transit service



Euro6IX Goal

- Support the fast introduction of IPv6 in Europe.
- Main Steps:
 - Network design & deployment
 - Research on network advanced services
 - Development of applications validated by user groups & international trials
 - Active dissemination:
 - participation in events/conferences/papers
 - contributions to standards
 - project web site



Objectives

1. Research an appropriate architecture, to design and deploy the first Pan-European non-commercial IPv6 Internet Exchange Network.
2. Use this infrastructure to research, test and validate IPv6-based applications & services.
3. Open the network to specific User Groups for its validation in trials.
4. Dissemination, liaison and coordination with clusters, fora, standards organizations (e.g. IETF, RIPE) and third parties.



Consortium Members (17)

- Telcos/ISPs (7):
 - Telecom Italia LAB (WP2 leader), Telefónica I+D (WP3 leader), Airtel-Vodafone, British Telecom Exact, T-Nova (Deutsche Telecom), France Telecom RD, Portugal Telecom Inovação
- Industrial (2):
 - 6Wind, Ericsson Telebit
- Universities (3):
 - Technical University of Madrid (WP4 leader), University of Southampton, University of Murcia
- Research, System Integrators and Consultancy (3):
 - Consulintel (WP1 leader and project coordinator), Telscom (WP5 leader), novaGnet systems
- Others (2):
 - Écija & Asociados Abogados, Eurocontrol



Sponsors & International Links

- Asia
 - Hitachi Internetworking
- Europe
 - Korak (Slovakia)
 - NTT Europe
 - Telia
- North America
 - Network Robots



Network Hierarchy

- Native IPv6 Internet Exchanges (IX).
- Core Network (interconnection between the IXs).
- Nodes (linked to the Core Network, through the regional IX).
- Abstract:

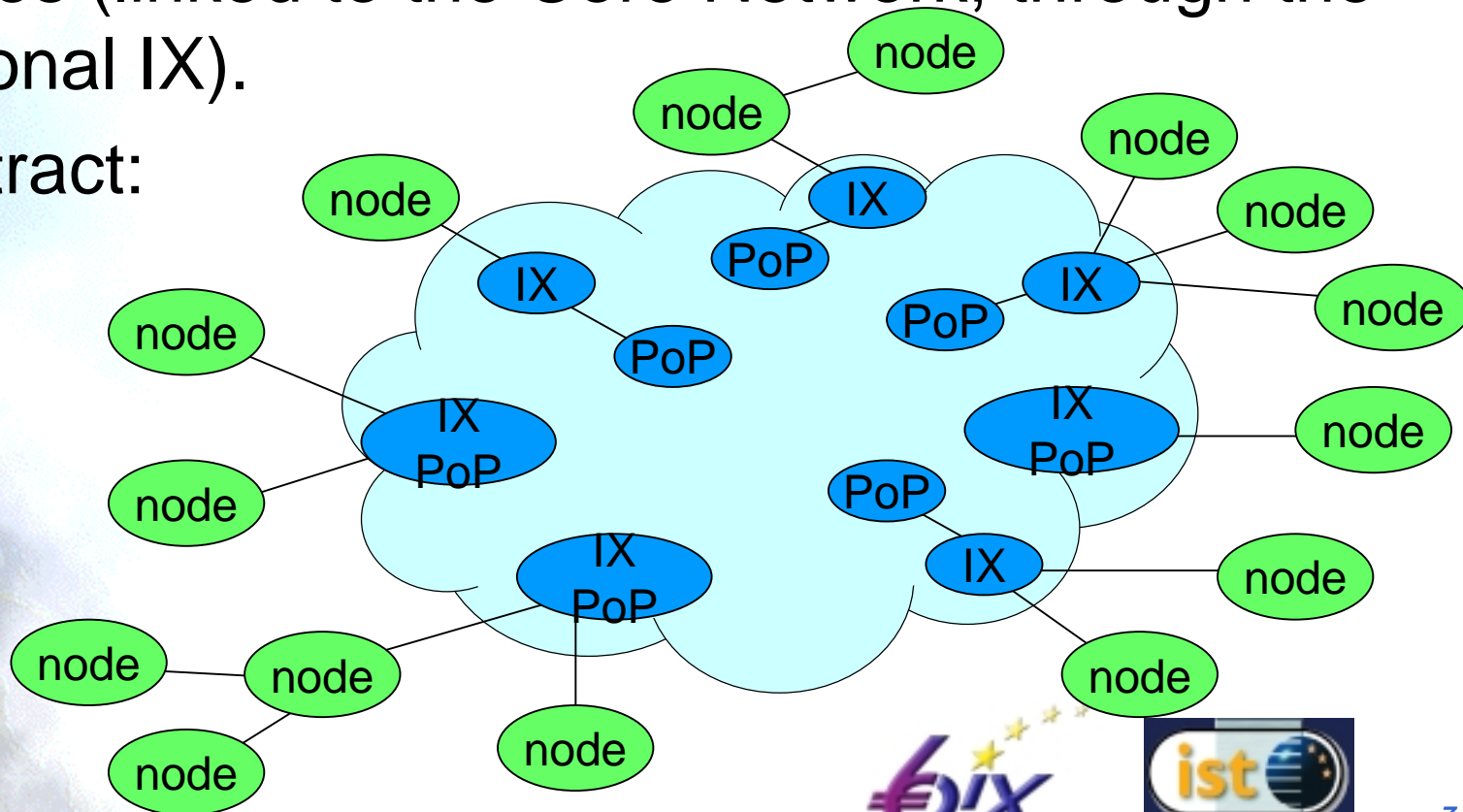

Network Map

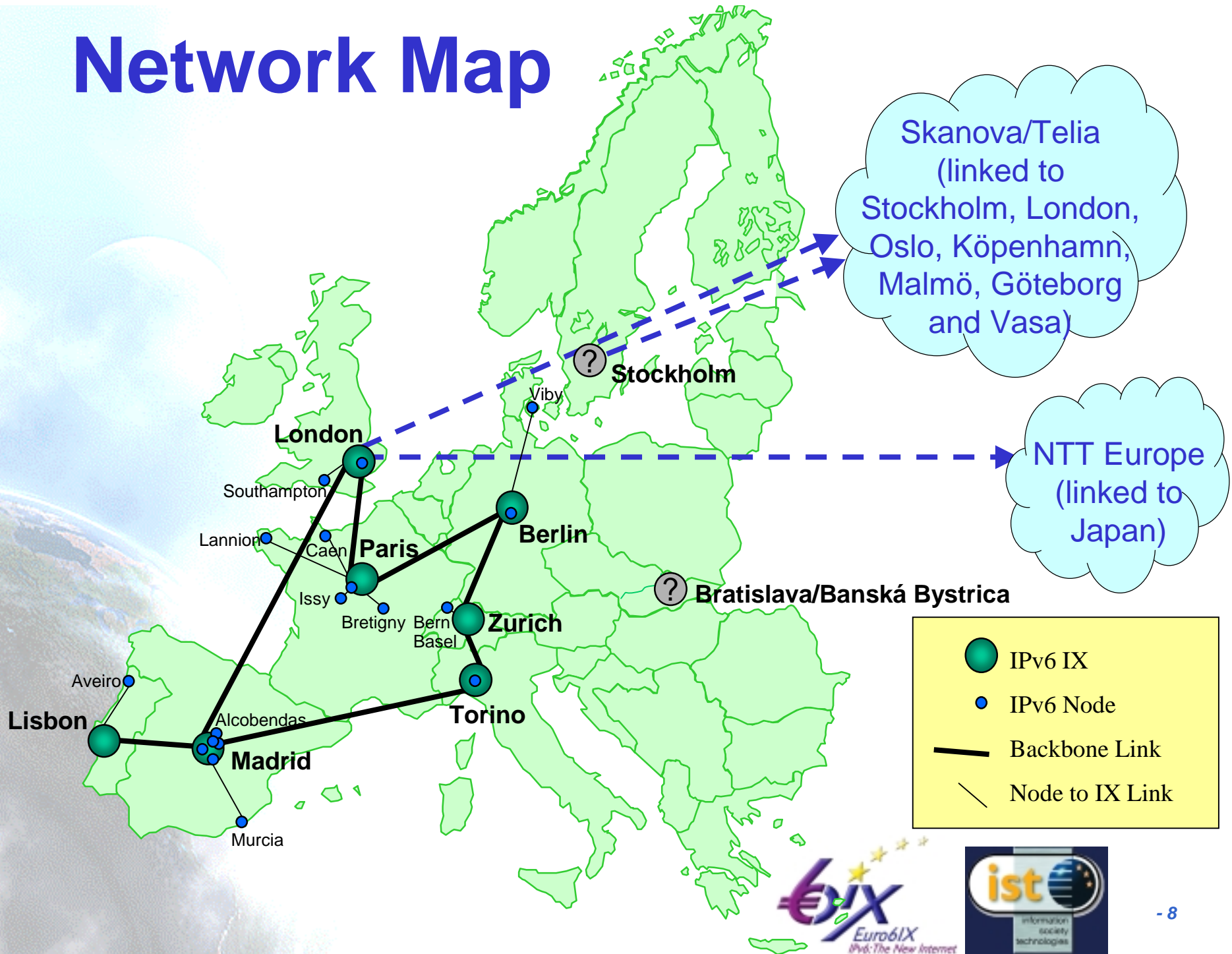

Infrastructure Set Up

1. GEANT or 6NET Network
2. Telcos related to partners in the Consortium
3. Telcos related to partners in the Consortium AND external service providers
4. External service providers



Possible Core Evolution

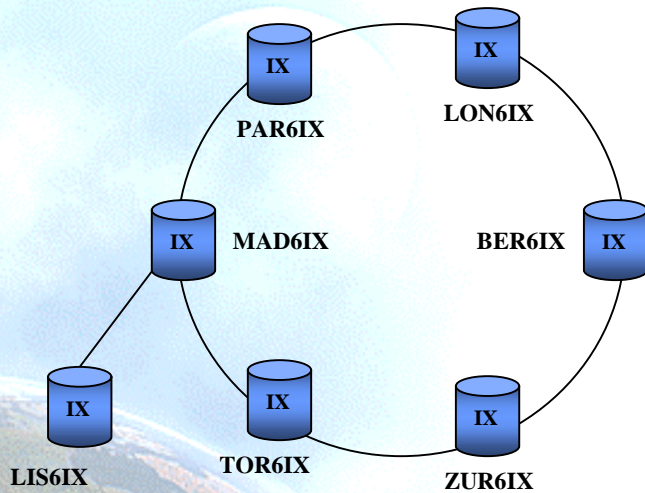

First Topology: Single Ring Topology

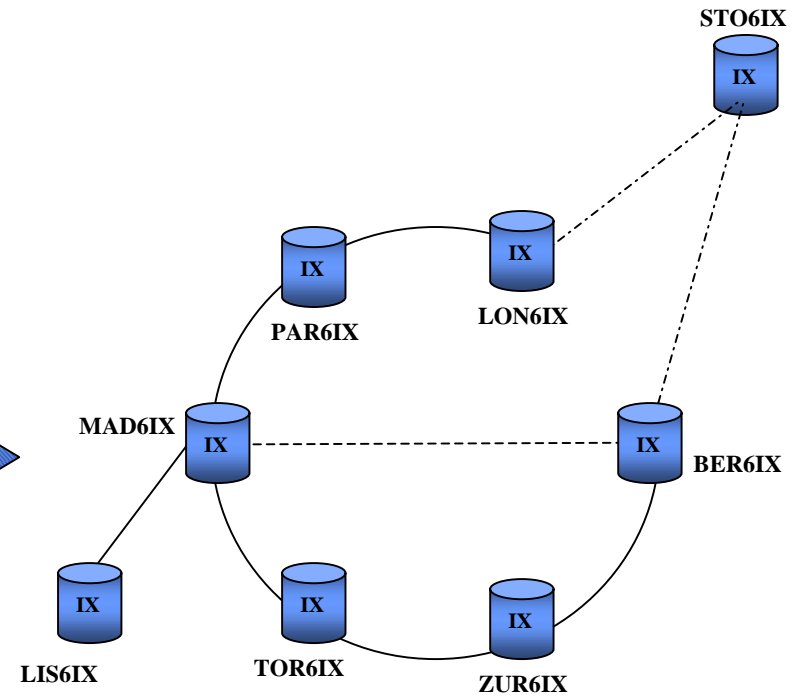

Evolution: Complex Topology with more IX's

IX's Nomenclature

MAD6IX	----	Madrid
PAR6IX	----	Paris
LON6IX	----	London
BER6IX	----	Berlin
ZUR6IX	----	Zurich
TOR6IX	----	Torino
LIS6IX	----	Lisbon
STO6IX	----	Stockholm



Nodes/IX Abstract (RFC 2374)

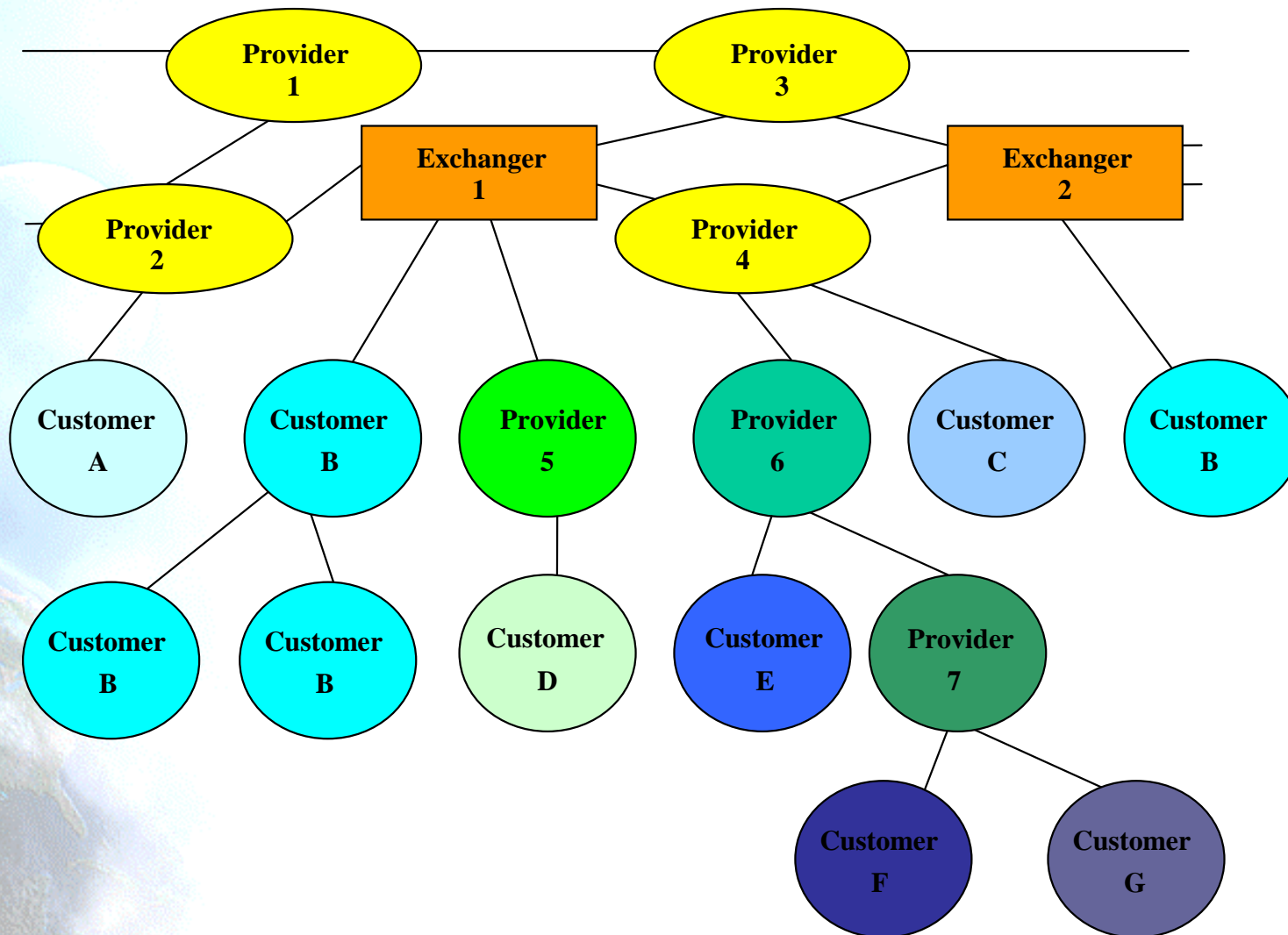

Node Prototype A

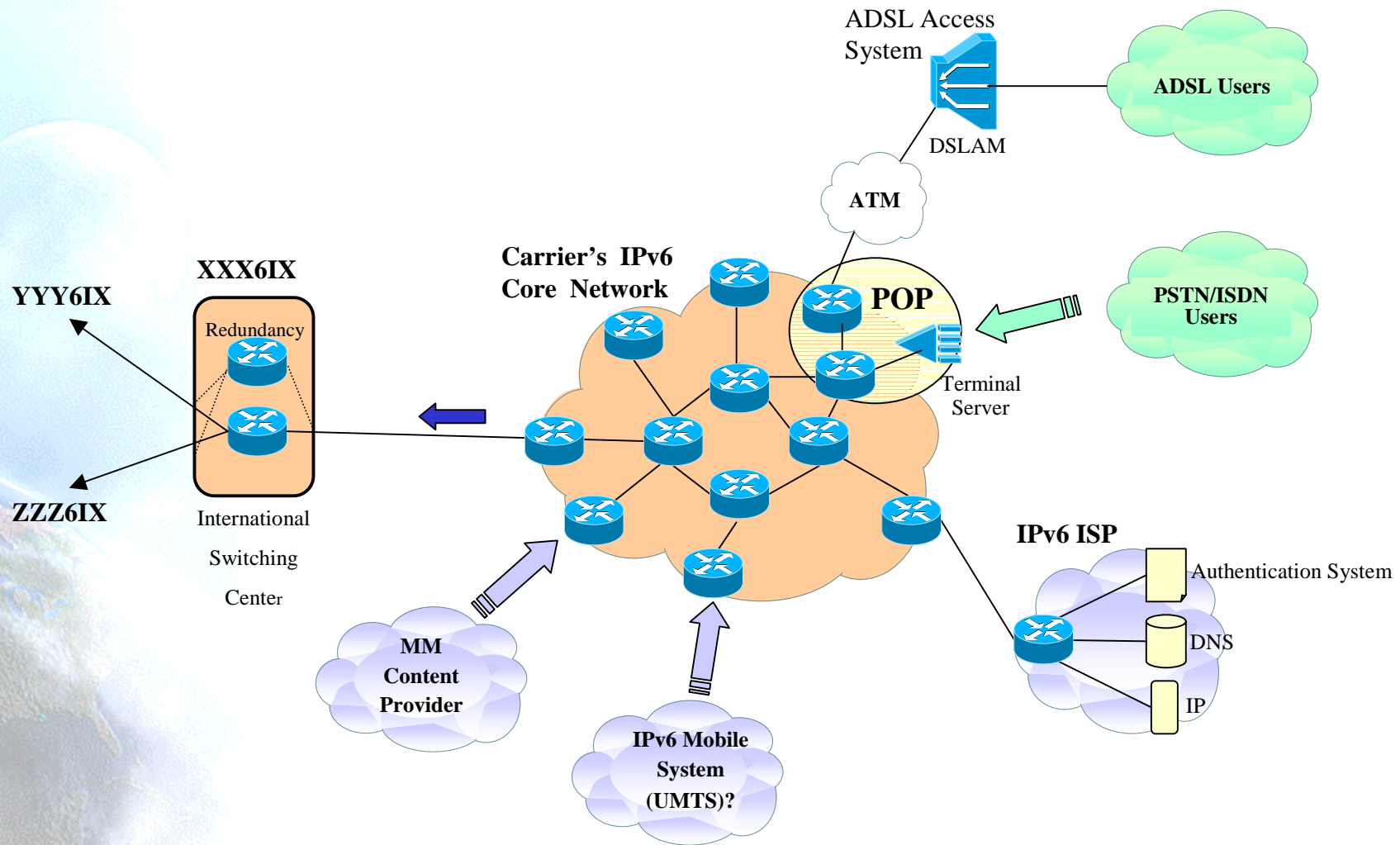

Node Prototype B

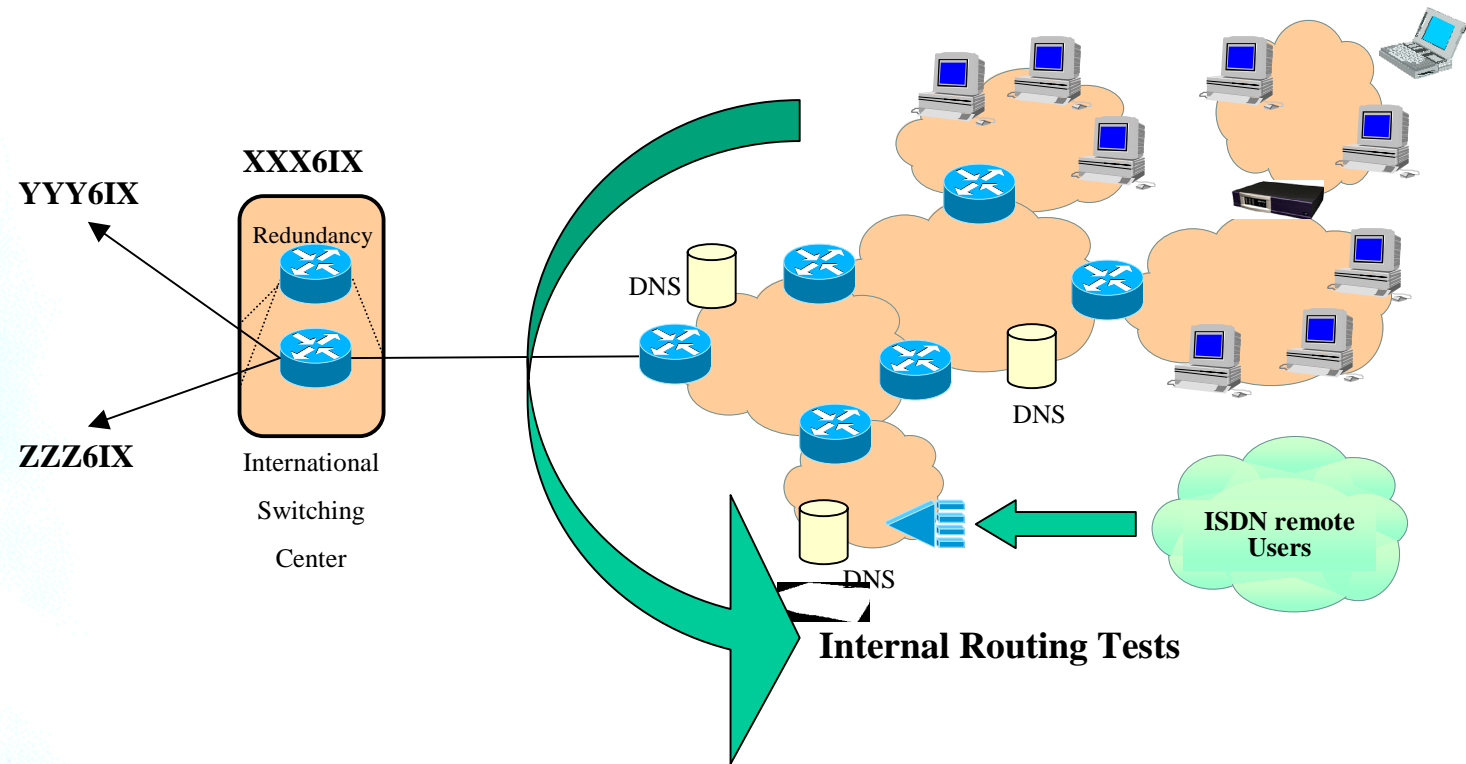

Node Prototype C

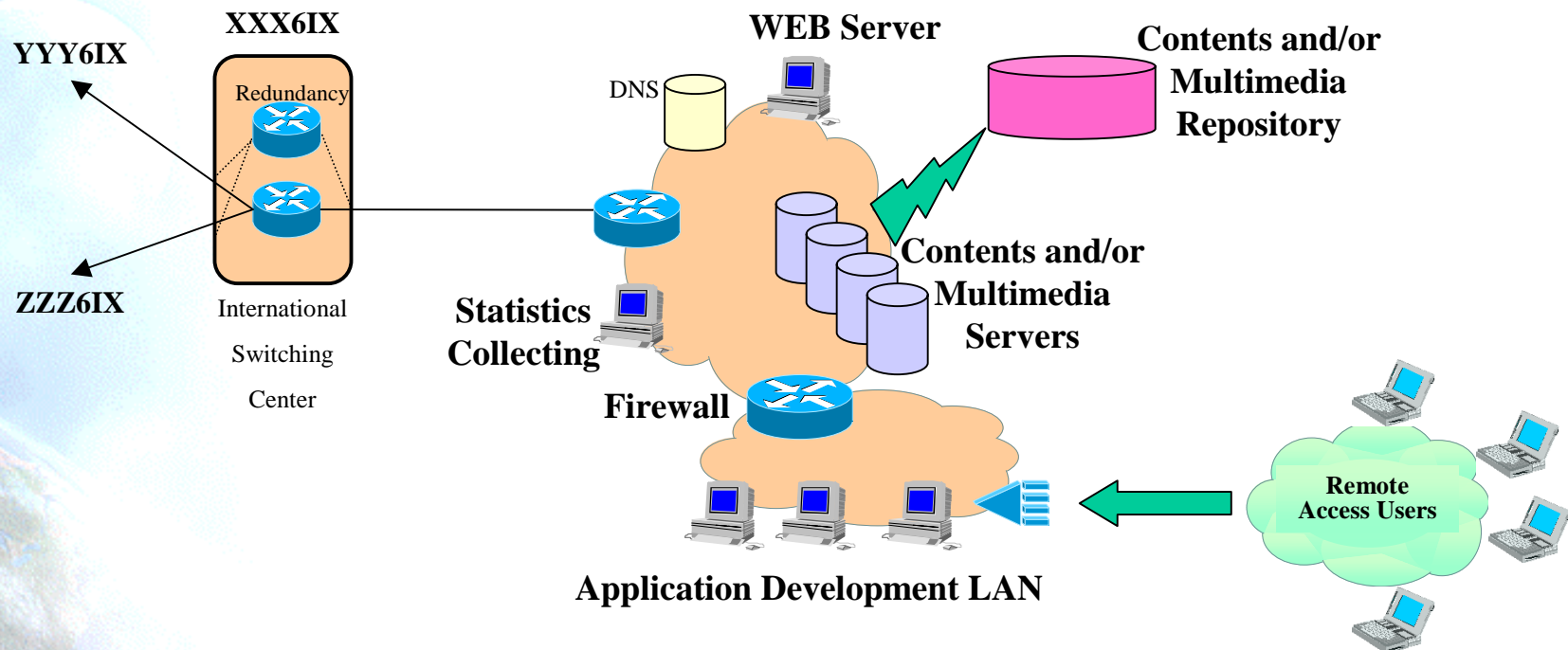

Work Package Summary

- WP1: Project Management
- WP2: Network Architecture Design
- WP3: Network Implementation
- WP4: Associated Research, Trials and Evaluation
- WP5: Liaison & Interconnection, Dissemination



Euro6IX Test-Bed Flow

- IPv6 test-beds will be designed in WP 2, implemented in WP 3 and tested in WP 4 trials. The outputs of these trials will be used to evaluate network design and to change the topology in consequence.

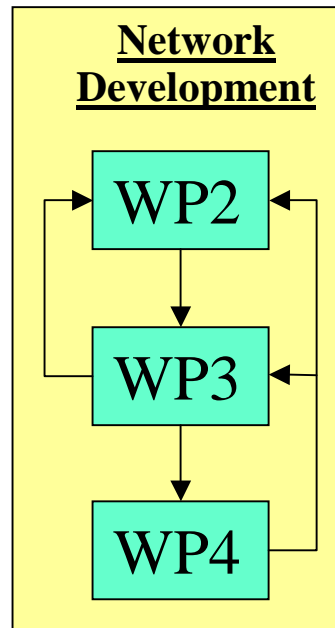

Research Activities (I)

- Network Advanced Services.
 - Mobility in IPv6 networks.
 - Multicast and Anycast on IPv6 networks.
 - Security and VPNs in IPv6 networks.
 - Multihoming and Renumbering issues.
 - Distributed Systems on IPv6 networks (Policy Languages and Framework).
 - QoS/CoS support on IPv6.
 - UDLR
 - Network Management and Operation tools
 - Billing and accounting.
- A4.1 within WP4

Research Activities (II)

- Applications Development.
 - Code porting (include Java).
 - Address Delegation WEB Tools.
 - Instant Messaging.
 - On-Line Education Tools.
 - Billing Tools Prototypes.
 - WEB Mail Tools.
 - Multimedia.
 - Web Site.
 - Shareware Repository.
 - Test Suites.
- A4.2 within WP4



Research Activities (III)

- Legal Implications of IPv6
 - Security, Privacy and Liberty Concerns
 - Legal Position in Relation to system/ISP
 - Data Protection and Personal Data
 - Legal issues of the project
 - Legal Concerns on IPRs
- A4.4 within WP4

Users Involvement & Trials

- Users Groups:
 - End-Users
 - Small/Medium Size Organizations
 - ISPs
- Yearly Trials
 - Internal
 - Public (with events, workshops, ...)
- A4.3 within WP4

Access Usage Policy (AUP)

- To avoid conflicts with IST Programme, or mislead future cooperation with other projects, research and academic networks.
- Nature of project: non-commercial backbone.
- User Group Definition that summarize these views:
 - Euro6IX will offer the use of the IPv6 native network for non-commercial traffic of R+D projects or organizations.



Interaction with 3G (GPRS/UMTS) test-beds

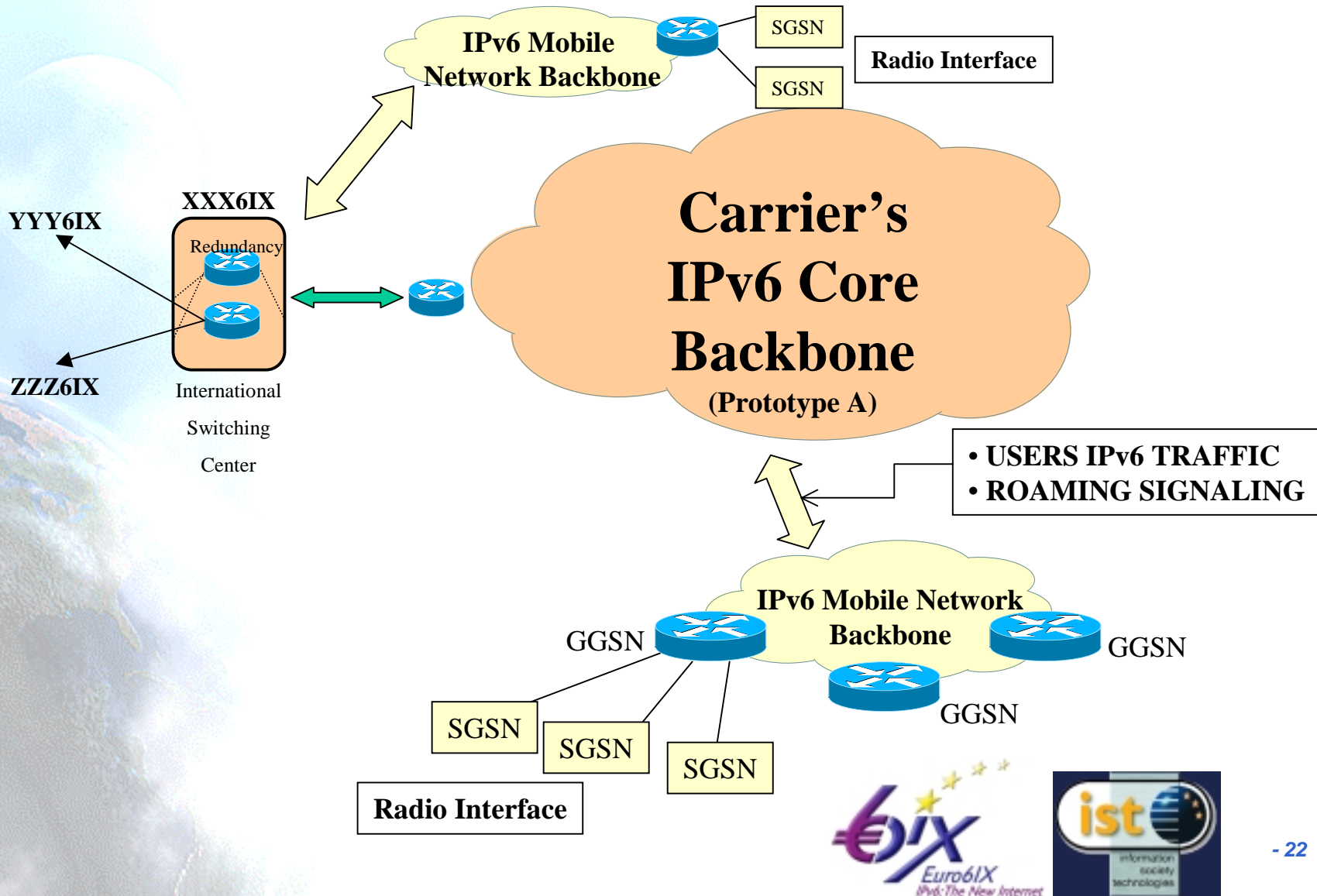

Interaction with IPv4 Networks

Transport

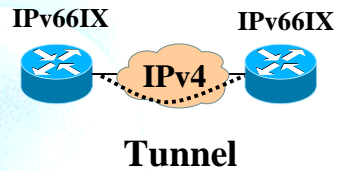

Translation

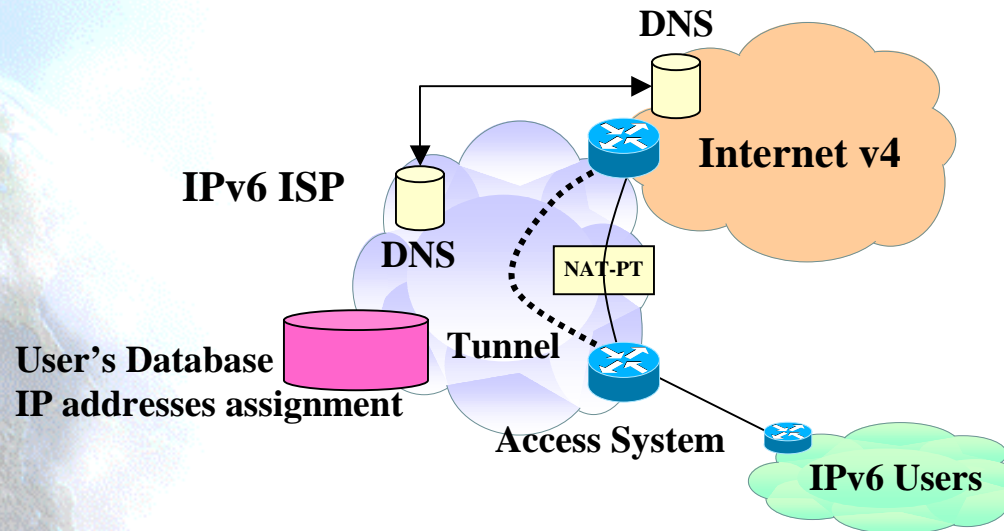
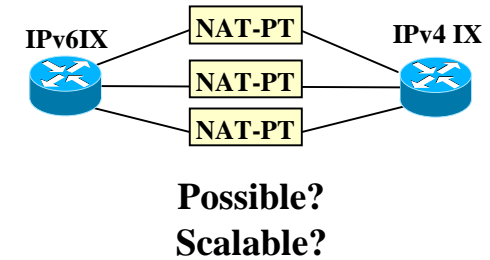

Items

- DNS issues
- Access, Authentication
- Tunnel and/or NAT-PT?

Dissemination and Liaison

- Linkage and Interconnection
 - Dissemination Activities
 - Liaison Activities
-
- Addressed within WP5
-
- Public Web Site
 - (www.euro6ix.net/com/org ... soon !)



Work Package Interrelation

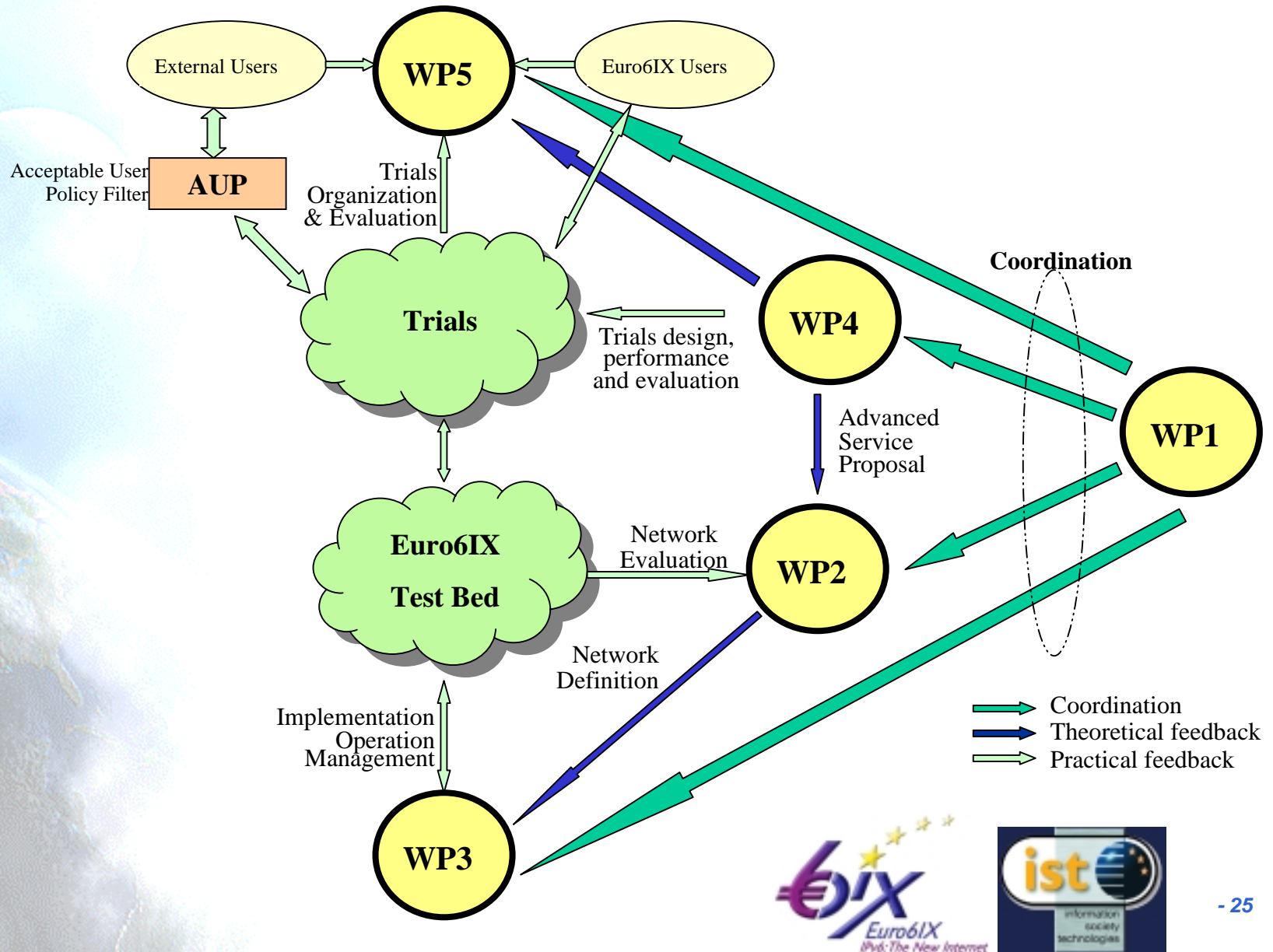

What Next ?

- Open to any related initiative
- Waiting for “customers”, not just pure research, willing to connect to our network

- AIM: all-IPv6 ...

for an IPv6-e-Europe



Thanks !

Disclaimer:

Euro6IX is still under negotiation (signature process)

**Pre-register at the next IPv6 Summit in Madrid 2002 at:
www.ipv6-es.com**

